

SPIRIT



CE900 Elliptical OWNER'S MANUAL

Please carefully read this entire manual before operating your new elliptical.

TABLE OF CONTENTS

Important Safety Instructions.....	2
Important Operation Instructions.....	3
Assembly Instructions.....	4
Getting On / Off Your Elliptical.....	10
Console Operation.....	12
Using heart rate transmitter.....	23
General Maintenance.....	22
Exploded View Diagram.....	23
Parts List.....	24

IMPORTANT SAFETY INSTRUCTIONS

WARNING - Read all instructions before using this exercise equipment.

WARNING - Heart rate monitoring systems may be inaccurate. Over exercising may result in serious injury or death. If you feel faint stop exercising immediately.

- Do not operate elliptical on deeply padded, plush or shag carpet. Damage to both carpet and elliptical may result.
- Keep children away from the elliptical. There are obvious pinch points and other caution areas that can cause harm.
- Keep hands away from all moving parts.
- Never drop or insert any object into any openings.
- Do not use outdoors.
- Do not attempt to use your elliptical for any purpose other than for the purpose it is intended.
- The hand pulse sensors are not medical devices. Various factors, including the user's movement, may affect the accuracy of heart rate readings. The pulse sensors are intended only as exercise aids in determining heart rate trends in general.
- Wear proper shoes. High heels, dress shoes, sandals or bare feet are not suitable for use on your elliptical. Quality athletic shoes are recommended to avoid leg fatigue.
- This exercise equipment can be used by children aged from 8 years and above and persons with reduced physical, sensory or mental capabilities or lack of experience and knowledge if they have been given supervision or instruction concerning use of the exercise equipment in a safe way and understand the hazards involved. Children shall not play with the exercise equipment. Cleaning and user maintenance shall not be made by children without supervision.
- Children should be supervised to ensure that they do not play with the exercise equipment.
- Notes on the correct posture and the fact the pedal crank training equipment of class B and C are not suitable for therapeutic purposes
- Be aware that the generator is producing AC power while the elliptical is being used. Do not service the elliptical while the generator is spinning; serious electric shock could occur.
- "WARNING! Heart rate monitoring systems may be inaccurate. Over exercising may result in serious injury or death. If you feel faint stop exercising immediately".
- **WARNING:** Injuries to health may result from incorrect or excessive training.
- The elliptical trainer is not equipped with a free wheel and therefore the moving parts cannot be stopped immediately.
- **WARNING:** The individual human power which is required to carry out an exercise can be different than the mechanical power displayed.
- This exercise equipment is not intended for use by persons (including children) with reduced physical, sensory or mental capabilities, or lack of experience and knowledge, unless they have been given supervision or instruction concerning use of the exercise equipment by a person responsible for their safety.
- Before beginning this or any exercise program, consult a physician. This is especially important for persons over the age of 35 or persons with pre-existing health conditions.
- Close supervision is necessary when this exercise equipment is used by, on, or near children, invalids, or disabled persons.

SAVE THESE INSTRUCTIONS - THINK SAFETY!

IMPORTANT ELECTRICAL INSTRUCTIONS

WARNING!

NEVER expose this elliptical to rain or moisture. This product is **NOT** designed for use outdoors, near a pool or spa, or in any other high humidity environment.

Important Operation Instructions

- **NEVER** operate this elliptical without reading and completely understanding the results of any operational change you request from the computer.
- **All users** should have medical clearance before starting any rigorous exercise program. This is especially important for persons with a history of heart disease or other high risk factors.
- Understand that changes in resistance do not occur immediately. Set your desired resistance level on the computer console and release the adjustment key. The computer will obey the command gradually.
- Use caution while participating in other activities while pedaling on your elliptical; such as watching television, reading, etc. These distractions may cause you to lose balance which may result in serious injury.
- Do not use excessive pressure on console control keys. They are precision set to function properly with little finger pressure.
- Always hold on to a handle bar while making control changes.
- Do not use excessive pressure on console control keys. They are precision set to function properly with little finger pressure. If you feel the buttons are not functioning properly with normal pressure contact your dealer.

ASSEMBLY INSTRUCTIONS

Max. user's weight.: 205 kg

UNPACKING

1. Cut the straps, then lift the box over the unit and unpack.
2. Locate the hardware package. The hardware is separated into four steps. Remove the tools first. Remove the hardware for each step as needed to avoid confusion. The numbers in the instructions that are in parenthesis (#) are the item number from the assembly drawing for reference.

ASSEMBLY TOOLS

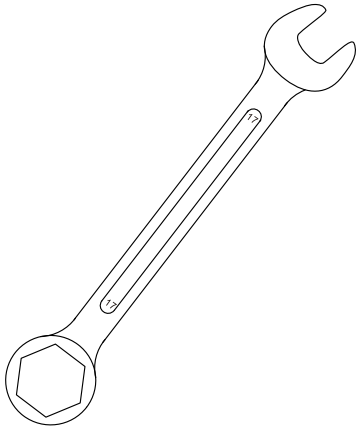

#135. 17 mm
Wrench (1 pc)

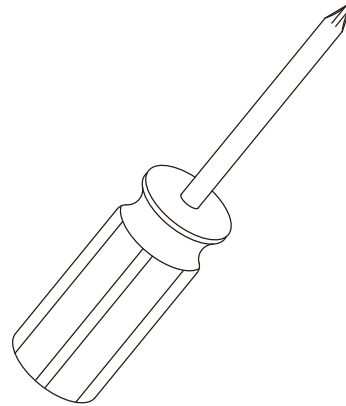

#131. Phillips Head
Screw driver (1 pc)

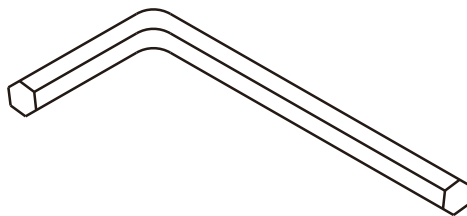

#134. M10 L Allen Wrench (1 pc)

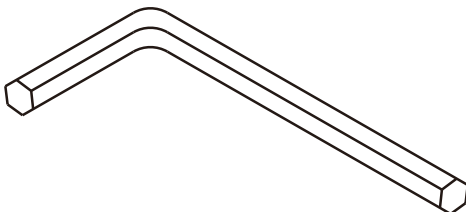

#133. 6mm L Allen Wrench (1 pc)

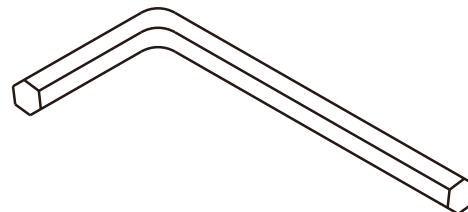

#132. 5mm L Allen Wrench (1 pc)

STEP 1



#46 – 3.5 × 12mm
Sheet Metal Screw
(2pcs)

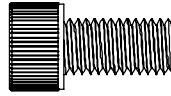

#54 – M10 × 20mm
Socket Head Cap Bolt
(12pcs)

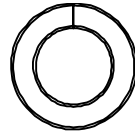

#57 – Ø10 × 2T
Split Washer (4pcs)

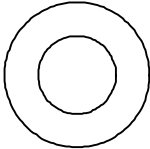

#65 – Ø3/8" × Ø19 × 1.5T
Flat Washer (4pcs)

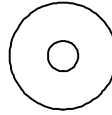

#58 – Ø4 × 14 × 1.0T
Flat Washer (2pcs)

STEP 2



#47 – 5 × 16m/m
Sheet Metal Screw (2pcs)

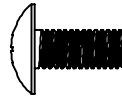

#49 – M5 × 12mm
Phillips Head Screw (6pcs)

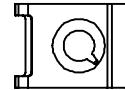

#78 – M5 × 1T Plate (2pcs)

STEP 3

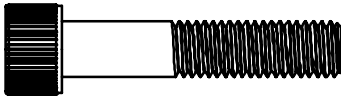

#43 – M10 × 55mm
Socket Head Cap Bolt
(2pcs)

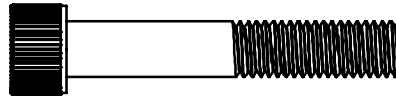

#44 – M10 × 60mm
Socket Head Cap Bolt
(4pcs)

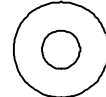

#63 – Ø10 × Ø25 × 1.5T
Flat Washer (10pcs)

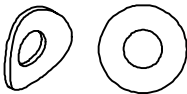

#68 – Ø10 × Ø23 × 1.5T
Curved Washer (2pcs)



#71 – M10 × 8T
Nyloc Nut (6pcs)

STEP 4

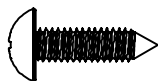

#46 – 3.5 × 12m/m
Sheet Metal Screw
(2pcs)

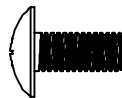

#49 – M5 × 12mm
Phillips Head Screw
(6pcs)

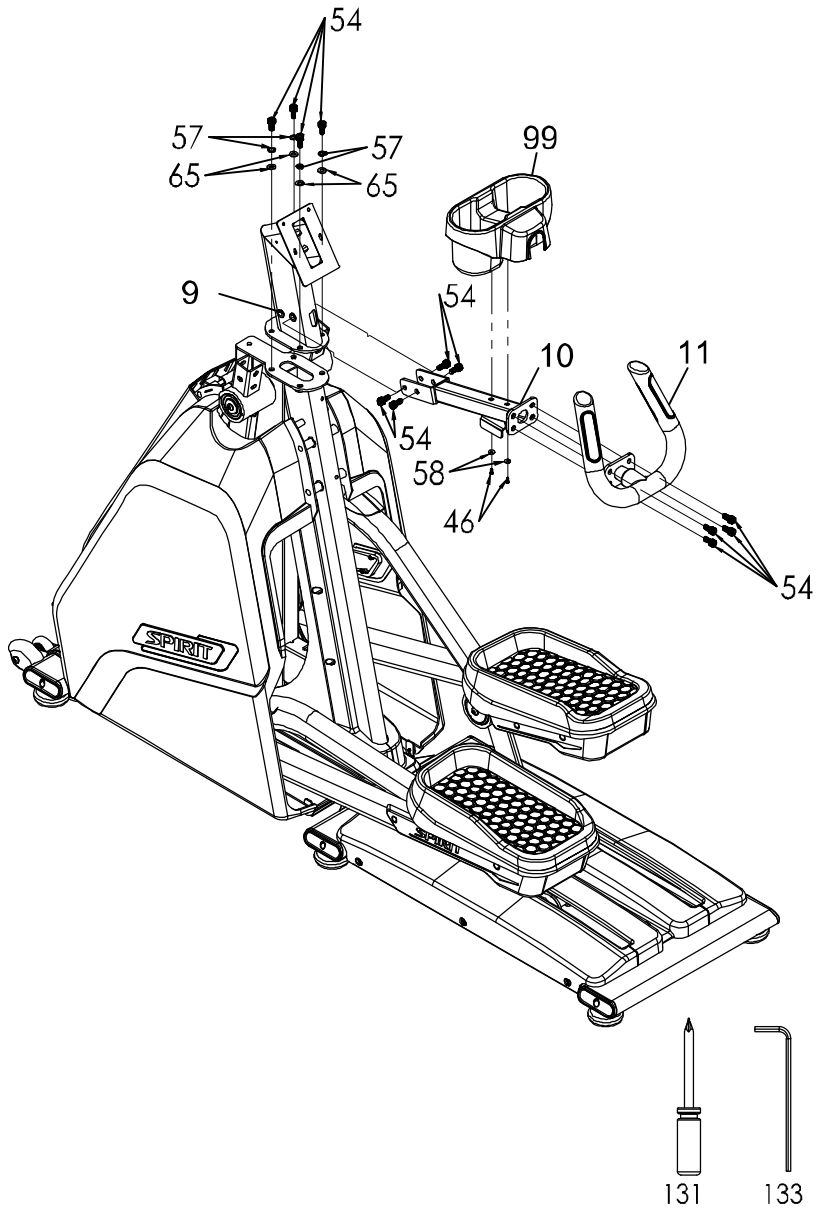

STEP 1

1. Unwind wiring harness and run wires up through CONSOLE MAST (9). Bolt CONSOLE MAST (9) to MAIN FRAME (1) using 4 BOLTS (54), 4 LOCK WASHERS (57), and 4 WASHERS (65). Do not pinch wires.
2. Run wires from CENTER HANDLEBARS (11) through HANDLEBAR BRACKET (10), into CONSOLE MAST (9) and out the top.
3. Install CENTER HANDLEBARS (11) to HANDLEBAR BRACKET (10) using 4 BOLTS (52).
4. Install HANDLEBAR BRACKET (10) to CONSOLE MAST (9) using 4 BOLTS (54).
5. Attach CUP HOLDER (99) to HANDLEBAR BRACKET (10) using 2 SELF-TAPPING SCREWS (46) and 2 WASHERS (58).

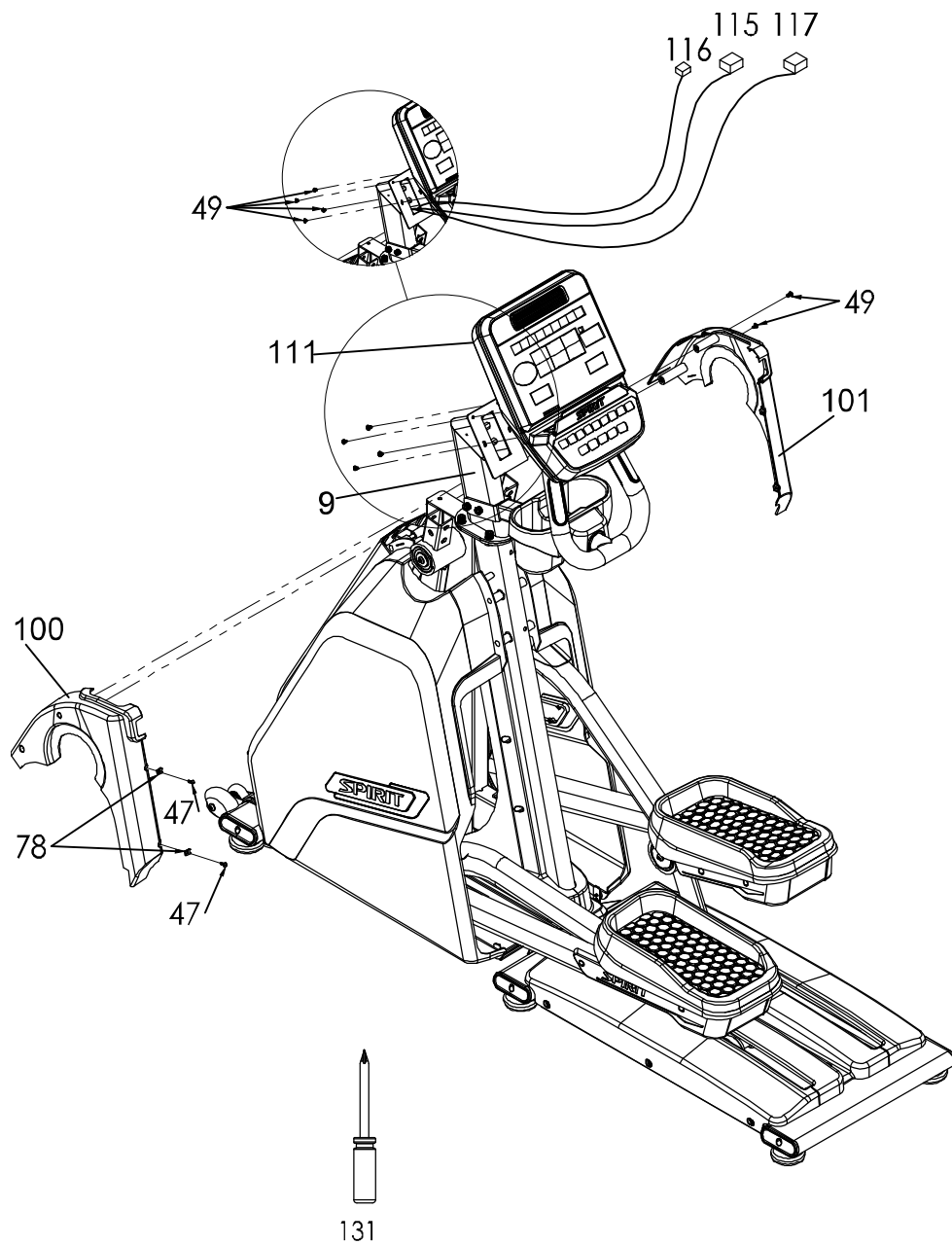

STEP 2

1. Install 2 U-NUTS (78) to LEFT CONSOLE MAST COVER (100).
2. Attach CONSOLE MAST COVERS (100 & 101) to MAIN FRAME (1) using 2 SELF-TAPPING SCREWS (47). Use 2 SCREWS (49) to connect covers to each other.
3. Plug in all wires from wiring harness to CONSOLE (111).
4. Install CONSOLE (111) to CONSOLE MAST (9) using 4 SCREWS (49). Be careful not to pinch any wires.

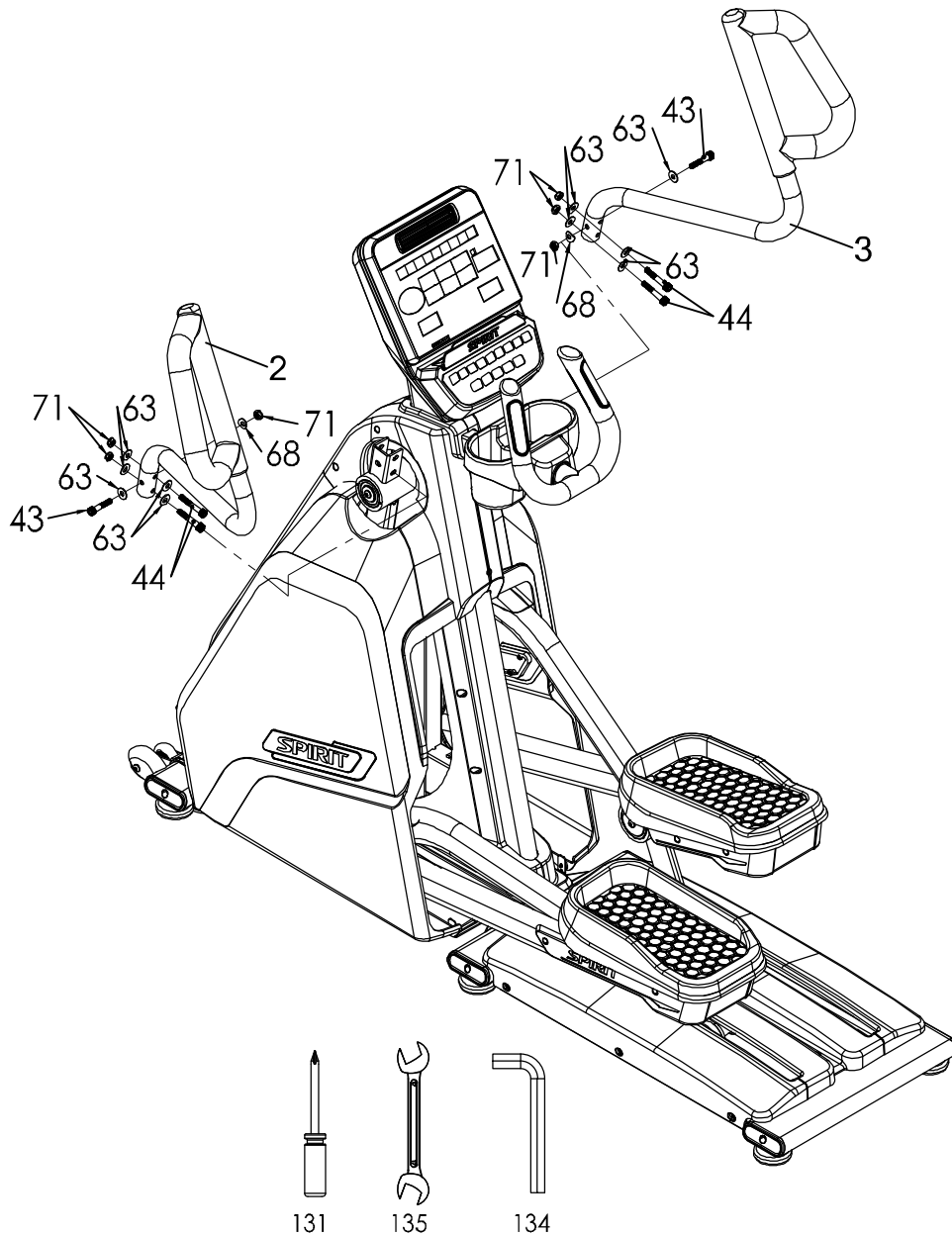

STEP 3

1. Install LEFT SIDE HANDLEBAR (2) to SWING ARM (12).
 - a) First install 2 longer BOLTS (44) with a WASHER (63) on both sides of SWING ARM (12) and a NUT (71). Do not tighten yet.
 - b) Then install 1 SHORTER BOLT (43) with a WASHER (63) through the SWING ARM (12) and CROSSTRAINING HANDLEBAR (2), using a CURVED WASHER (68) and a NUT (71) on the back side.
 - c) Tighten after all hardware is installed.
2. Repeat process for RIGHT SIDE HANDLEBAR (3).

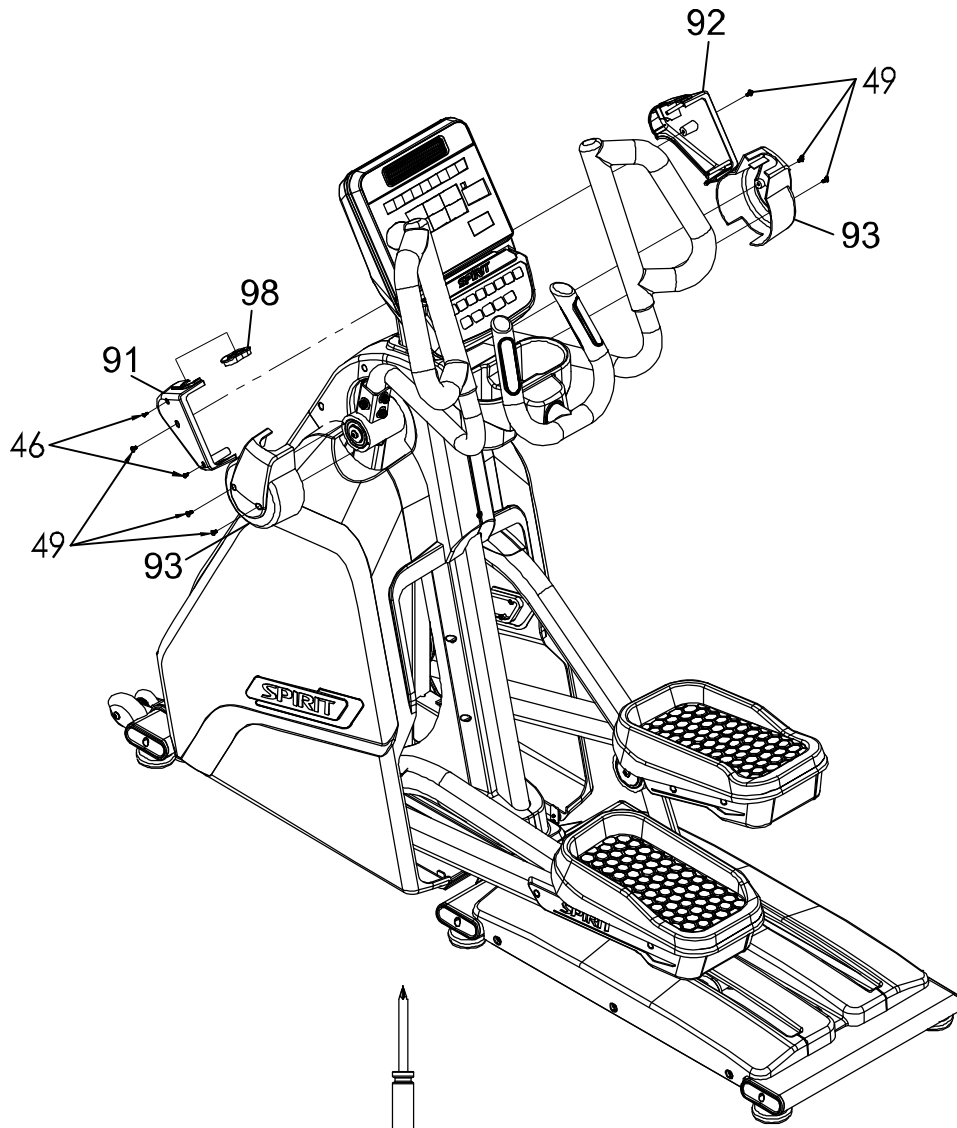

131

STEP 4

1. Attach CONSOLE BRACKET COVERS (91 & 92) to CONSOLE MAST (9) using 2 SCREWS (49). Connect covers together using 2 SELF-TAPPING SCREWS (46).
2. Attach left SWING ARM HINGE COVER (93) to SWING ARM (12) using 2 SCREWS (49). Repeat for right side.

GETTING ON / OFF YOUR ELLIPTICAL

IMPORTANT

The elliptical comes with two Dual Action Handles and a Stationary Handlebar.

Always hold the Stationary Handlebar when getting on and off the elliptical.

First time users should familiarize themselves with using the elliptical by using the Stationary Handlebar first and then progressing to the Dual Action Handles.

Once you have familiarized yourself with using the elliptical, you can progress to using the Dual Action Handles to provide a total body workout. Hands can be positioned on the Dual Action Handles at the most appropriate position for your height and arm length.

Caution should always be taken when getting on and off any exercise machine.
Please follow the safety steps below.

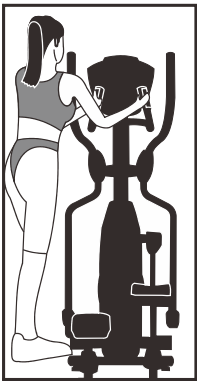

Ensure the left Foot Pedal is in the lowest position and grasp the Stationary Handlebar with both hands.

Place your left foot on the left Foot Pedal and get secure.

Lift your right foot over machine and place on right Foot Pedal. Get balanced and begin your workout.

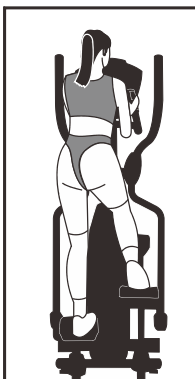
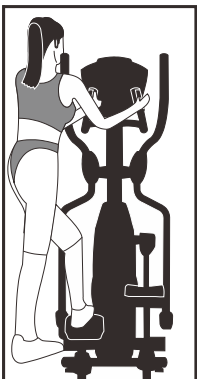

Important

To get off, come to a complete stop and reverse the procedure.

Always wear rubber-soled shoes, such as tennis shoes.

It is recommended that you keep at least one hand on the Stationary Handlebar at all times, especially when getting on or off. If you are performing a walking action with your arms, or doing upper body strength training exercises, ensure you are well balanced.

All equipment should be set-up and operated on solid, level surfaces.

Correct Position



Your body should be in an upright position so that your back is straight. Keep your head up to minimize neck and upper back strain. Always try and use the elliptical in a rhythmical and smooth motion. If you find yourself feeling uncomfortable, or experience a surging type feeling, there is probably too much tension.

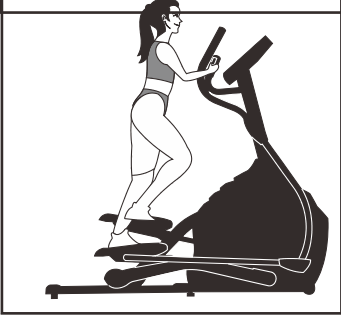

The elliptical can be used in forward or reverse motion.

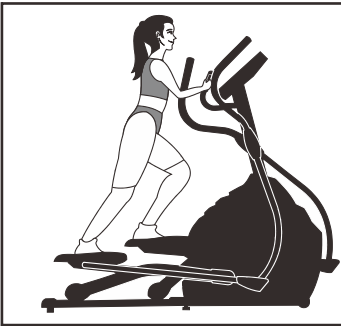

When going in reverse, bend your knees slightly more. More emphasis is on the buttocks and hamstrings in the reverse motion.

MOVING YOUR ELLIPTICAL

The elliptical can be easily moved.



1. At the rear of the machine squat down and grasp the rear stabilizer bar.

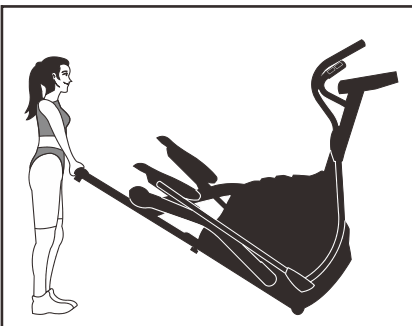

2. Lift the rear of the machine using your legs until the wheels in the front engage with the ground.

CONSOLE OPERATION

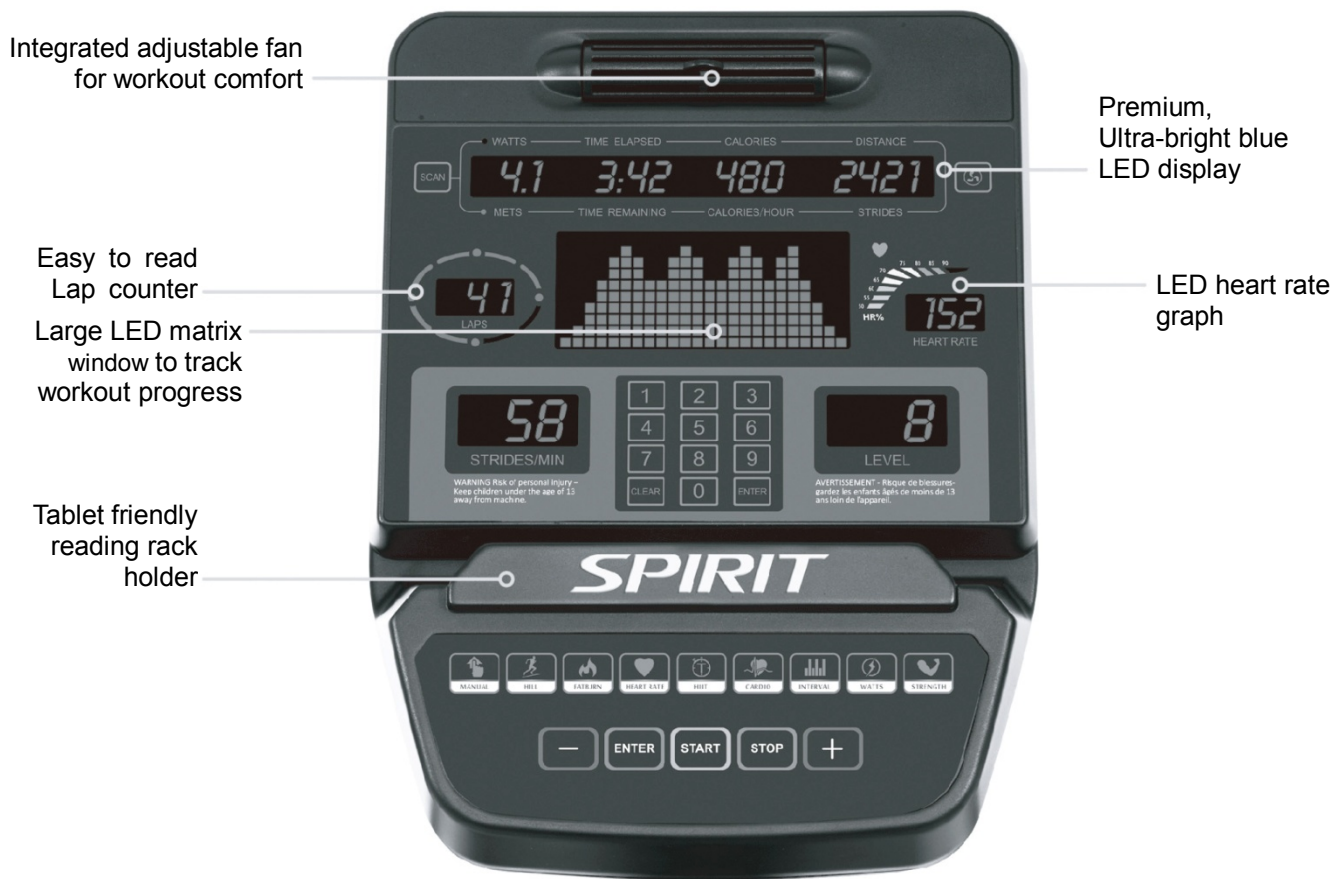

POWER

Spirit Fitness commercial elliptical trainers have a built-in generator for power and do not need to be plugged into an AC outlet. To power up the elliptical trainer simply start to pedal, the console will turn on automatically.

When initially powered on, the console will perform an internal self-test. During this time the display may not light up for a few seconds. Continue pedaling and the display will light up. Once powered on, the Message Window will be scrolling the start-up message. You may now begin your workout program.

C-SAFE FEATURE

Your console is equipped with a C-SAFE feature. The Power (POWER) port can be used for powering a remote controlled audio-visual system by connecting a cable from the remote to the Power port at the back of the console. The Communication port (COMM) can be used to interact with fitness software applications.

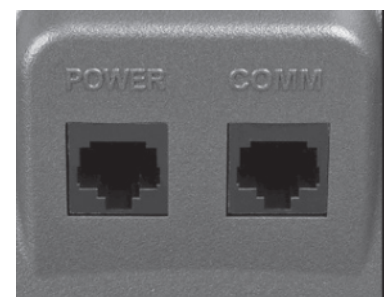

QUICK START

This is the quickest way to start a workout. After the console powers up you just press the Start key to begin. This will initiate the Quick Start mode. In Quick Start the Time will count up from zero, all workout data will start to accrue and the workload may be adjusted manually by pressing the Up and Down buttons. The dot matrix display will show just the bottom row lit. As you increase the workload more rows will light indicating a harder workout. The elliptical trainer will get harder to pedal as the rows increase. The dot matrix has 24 columns of lights and each column represents 1 minute. At the end of the 24th column (or 24 minutes of work) the display will wrap around and start at the first column again.

There are 40 levels of resistance – displayed as 10 rows of lights – available for plenty of variety. The first 10 levels are very easy workloads, and the changes between levels are set to a good progression for de-conditioned users. Levels 10-20 are more challenging but the increases from one level to the next remain small. Levels 20-30 start getting tough as the levels jump more dramatically. Levels 30-40 are extremely hard and are good for short interval peaks and elite athletic training.

BASIC INFORMATION

The Dot Matrix, or Profile Window, will display the workout Profile. The Message window displays pertinent exercise data. There is a Strides Per Minute window for pedal speed and a Level window indicating machine resistance. A Heart Rate data window and bar graph show how hard you are working and a lap counter provides distance information.

The Message Window will initially be displaying Watts, Time Elapsed, Calories and Distance information. On the left of the Message Window is a button labeled Scan. When the Scan button is pressed the next set of information will appear: METs, Time Remaining, Calories/Hour and Strides (total stride count). Pressing the Scan button, the Scan mode is activated and the Message Window will show each set of data for four seconds then switch to the next set of data in a continuous loop. Pressing the Scan button again will bring you back to the beginning.

To the right of the Profile Window is a Heart Icon, Heart Rate number display and a Bar Graph. The elliptical trainer has a built-in heart rate monitoring system. Simply grasping the hand pulse sensors, or wearing a heart rate chest belt transmitter, will start the Heart Icon blinking (this may take a few seconds). The Heart Rate window will display your heart rate, or Pulse, in beats per minute. The Bar Graph represents the percentage of your maximum heart rate you are currently achieving.

NOTE: You must enter your age during program setup for the Bar Graph to be accurate..

The Stop key button actually has several functions. Pressing the Stop key once during a program will pause the program for 5 minutes (when you stop pedaling without AC power the display will turn off but the memory will be saved for 5 minutes just like the pause mode). If you need to get a drink, answer the phone, or any of the many things that could interrupt your workout, this is a great feature. To resume your workout during Pause just press the Start key or start pedaling. If the Stop key is pressed twice during a workout, the program will end and the console will return to the start-up screen. If the Stop key button is held down for 3 seconds, the console will perform a complete Reset. During data entry for a program the Stop key performs a Previous Screen function. This allows you to go back one step in the programming each time you press the Stop key button.

The Program Keys are used to preview each program. When you first turn the console on, you may press each program key to preview what the program profile looks like. If you decide that you want to try a program, press the corresponding program key and then press the Enter key to select the program and enter into the data set-up mode.

NUMBER KEY PAD

When you are in the data set-up mode setting new data such as age, weight etc., you can use these keys to enter the numbers quickly.

The console includes a built-in fan to help keep you cool. To turn the fan on, press the key on the upper right side of the console. This is a 3-speed fan and each time you press the key the airflow will increase accordingly. After the third setting the fan will turn off when the key is pressed again.

PROGRAMMING THE CONSOLE

Each of the programs can be customized with your personal information and changed to suit your needs. Some of the information asked for is necessary to ensure the readouts are correct. You will be asked for your Age and Weight. Entering your Age ensures that the Heart Rate bar graph shows the correct number. Your Age is also necessary during the Heart Rate control program to ensure the correct settings are in the program for your Age. Otherwise the work settings could be too high or low for you; entering your Weight aides in calculating a more correct Calorie reading. Although we cannot provide an exact calorie count we do want to be as close as possible.

CALORIE NOTE: Calorie readings on every piece of exercise equipment, whether it is in a gym or at home, are not accurate and tend to vary widely. They are meant only as a guide to monitor your progress from workout to workout. The only way to measure your calorie burn accurately is in a clinical setting connected to a host of machines. This is because every person is different and burns calories at a different rate. Some good news is that you will continue to burn calories at an accelerated rate for at least an hour after you have finished exercising!

ENTERING A PROGRAM & CHANGING SETTINGS

When you enter a program (by pressing a program key then Enter key) you have the option of entering your own personal settings. If you want to work out without entering new settings, then just press the Start key. This will bypass the programming of data and take you directly to the start of your workout. If you want to change the personal settings, then just follow the instructions in the Message Window. If you start a program without changing the settings, the default, or pre-saved settings will be used.

MANUAL

The Manual program works as the name implies, manually. This means that you control the workload yourself and not the computer. To start the Manual program, follow the instructions below or just press the Manual button then the Enter button and follow the directions in the Message Window.

1. Press the Manual key then press the Enter key.
2. The Message Window will ask you to enter your Age. You may enter your Age, using the Up and Down keys or the numeric key pad, then press the Enter key to accept the new number and proceed on to the next screen.
3. You are now asked to enter your Weight. You may adjust the Weight number using the Up and Down keys, or the numeric key pad, then press enter to continue.
4. The next setting is Time. You may adjust the Time and press enter to continue.
5. Now you are finished editing the settings and can begin your workout by pressing the Start key. You can also go back and modify your settings by pressing the Enter key. *NOTE: At any time during the editing of data you can press the Stop key to go back one level, or screen.*
6. The program automatically starts you at level one. This is the easiest level and it is a good idea to stay at level one for a while to warm up. If you want to increase the work load at any time press the Up key; the Down key will decrease the workload.
7. When the program ends you may press Start to begin the same program again or Stop to exit the program.

PRESET PROGRAMS

The elliptical trainer has five different programs that have been designed for a variety of workouts. These five programs have factory preset work level profiles for achieving different goals.

HILL

This program follows a triangle or pyramid type of gradual progression from approximately 10% of maximum effort (the level that you chose before starting this program) up to a maximum effort which lasts for 10% of the total workout time, then a gradual regression of resistance back to approximately 10% of maximum effort.

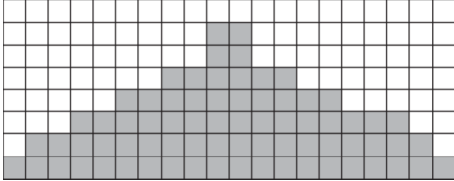

FATBURN

This program follows a quick progression up to the maximum resistance level (default or user input level) that is sustained for 2/3 of the workout. This program will challenge your ability to sustain your energy output for an extended period of time.

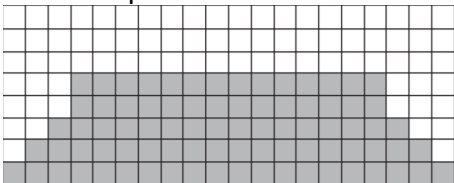

CARDIO

This program presents a quick progression up to near maximum resistance level (default or user input level). It has slight fluctuations up and down to allow your heart rate to elevate, and then recover repeatedly, before beginning a quick cool down. This will build up your heart muscle and increase blood flow and lung capacity.

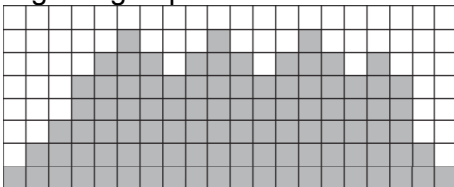

STRENGTH

This program has a gradual progression of resistance up to 100% of maximum effort that is sustained for 25% of workout duration. This will help build strength and muscular endurance in the lower body and glutes. A brief cool down follows.

INTERVAL

This program takes you through high levels of intensity followed by recovery periods of low intensity. This program utilizes and develops your "Fast Twitch" muscle fibers which are used when performing tasks that are intense and short in duration. These deplete your oxygen level and spike your heart rate, followed by periods of recovery and heart rate drop to replenish oxygen. Your cardiovascular system gets programmed to use oxygen more efficiently.

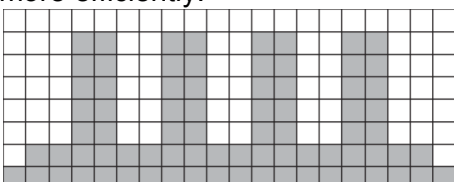

PROGRAMMING PRESET PROGRAMS

1. Select the desired program button then press the Enter key.
2. The Message Window will ask you to enter your Age. You may adjust the age setting, using the Up and Down keys, then press the Enter key to accept the new number and proceed on to the next screen.
3. You are now asked to enter your Weight. You may adjust the weight number using the Up and Down keys, then press Enter to continue.
4. Next is Time. You may adjust the Time and press Enter to continue.
5. Now you are asked to adjust the Max Level. This is the peak exertion level you will experience during the program (at the top of the hill). Adjust the level and then press Enter.
6. Now you are finished editing the settings and can begin your workout by pressing the Start key. You can also go back and modify your settings by pressing the Stop key to go back one level, or screen.
7. If you want to increase or decrease the workload at any time during the program press the Up or Down key. This will change the workload settings of the entire profile, although the profile picture on the screen will not change. The reason for this is so that you can see the entire profile at all times. If the profile picture is changed it will look distorted and not a true representation of the actual profile.
When you make a change to the workload, the Message Window will show both the current column and program maximum levels of work.
8. During the program you will be able to scroll through the data in the Message Window by pressing the Scan key next to the Message Window.
9. When the program ends the Message Window and data windows will show a summary of your workout. The summary will be displayed for a short time then the console will return to the start-up display.

HIIT PROGRAM

The HIIT, or High Intensity Interval Training, program takes advantage of the latest trend in fitness. During the program you will perform short bursts of high intensity sprinting followed by short rest periods. HIIT is a fully customizable interval training program. You can enter the number of intervals, time of each interval Sprint and Rest periods and the work intensity of the levels.

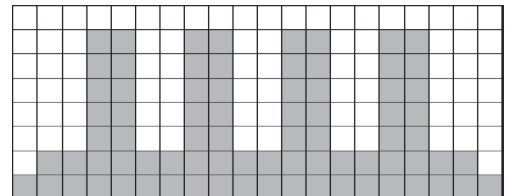

1. Press the HIIT key then Enter. The Message Window will ask you to enter your Age. You may enter your Age, using the Up and Down keys or the numeric key pad, then press the Enter key to accept the new number and proceed on to the next screen.
2. You are now asked to enter your Weight. You may adjust the Weight number using the Up and Down keys or the numeric key pad then press enter to continue.
3. Next you are asked for the number of intervals you want to do. The default is 10 and the range available is 3 to 15. One interval equals 1 Sprint and 1 Rest segment.
4. Now you are asked to adjust the Sprint Level. This is the resistance level you will experience during the Sprint segments of the program. Adjust the level and then press Enter.
5. Now you are asked to adjust the Rest Level. This is the resistance level you will experience during the Rest segments of the program. Adjust the level and then press Enter.
6. Next is entering the Interval time. The Message window shows: Sprint :30 | Rest :30. The Sprint time will be blinking. You may use the + - keys to adjust the Sprint time from 20 to 60 seconds then press Enter. The time for the Rest period will blink and you can adjust the time using the +- keys and press Enter.

7. The Message window will now display the total time for the HIIT workout; now press Start to begin. There is a 3-minute warm-up period before the first Sprint begins. The resistance level during warm-up is set to 5 but can be adjusted manually.
8. The dot matrix display in the HIIT program is a speed indication display, not a power or resistance display. During the Sprint the dot matrix display will show a blinking LED at the first Sprint segment. That is the target speed LED and indicates 90 pedal rpm. As you pedal faster the lights below the target speed LED light up the faster you go. When you exceed 90 rpm the target LED will move up showing you are past the target speed. You should maintain at least 90 rpm throughout the Sprint segments. The rest segments of the HIIT program are set to resistance level 5 and you can pedal at any speed you choose as your heart rate recovers. You can manually adjust the resistance levels during the Sprint and Rest segments.
9. At the end of the last Sprint there is a 3-minute cool-down period. You can bypass this by pressing the Stop key and the workout summary will be displayed.

HEART RATE PROGRAM OPERATION

Heart rate information is read via pulse grips or wireless chest strap. To start the HR program, follow the instructions below or just press the HR key then the Enter button and follow the directions in the Message Window.

1. Press the HR key then press the Enter key.
2. The message window will ask you to enter your Age. You may enter your Age, using the Up/Down keys or the numeric key pad, then press the Enter key to accept the new number and proceed on to the next screen.
3. You are now asked to enter your Weight. You may adjust the Weight number using the Up/Down keys or the numeric key pad, then press Enter to continue.
4. Next is Time. You may adjust the Time and press Enter to continue.
5. Now you are asked to adjust your target Heart Rate. This is the heart rate level you will try to maintain during the program. Adjust the value and then press Enter.
6. Now you are finished editing the settings and can begin your workout by pressing the Start key. You can also go back and modify your settings by pressing the Enter key. *Note: At any time during the editing of data you can press the Stop key to go back one level, or screen.*
7. If you want to increase or decrease the resistance at any time during the program press the Up/Down key. This will allow you to change your target heart rate at any time during the program.
8. The program will automatically increase or decrease the amount of resistance, depending on whether your heart rate is above or below your target.
9. During the HR program you will be able to scroll through the data in the Message Window by pressing the adjacent Display key.

CONSTANT WATT PROGRAM

The Watts program maintains a constant work load. The resistance Level adjusts when the speed is changed. To start the Constant Watt program, follow the instructions below or just press the Watt key then the Enter button and follow the directions in the Message Window.

1. Press the Watt key then press the Enter key.
2. The Message Window will ask you to enter your Age. Input your Age, using the Up/Down keys or the numeric key pad, then press the Enter key to accept the new age and proceed on to the next screen.
3. You are now asked to enter your Weight. Adjust Weight using the Up/Down keys or the numeric key pad, then press Enter to continue.
4. Next is Time. Adjust the Time then press Enter to continue.
5. Now you are asked to adjust the Target Watt Level. This is the constant power you will experience during the program. Adjust using the Up/Down keys, then press Enter.
6. Now you are finished editing the settings and can begin your workout by pressing the Start key. You can also go back and modify your settings by pressing the Enter key. *Note: At any time during the editing of data, you can press the Stop key to go back one level, or screen.*
7. If you want to increase or decrease the workload at any time during the program, press the Up/Down key. This will allow you to change your target Watt level at any time during the program.
8. During the Constant Power program you will be able to scroll through the data in the Message Window by pressing the adjacent Scan key.
9. When the program ends, you may press Start to begin the same program again or Stop to exit the program.

HEART RATE TRAINING

The old motto, “no pain, no gain”, is a myth that has been overpowered by the benefits of exercising comfortably. A great deal of this success has been promoted by the use of heart rate monitors. With the proper use of a heart rate monitor, many people find that their usual choice of exercise intensity was either too high or too low and exercise is much more enjoyable by maintaining their heart rate in the desired benefit range.

To determine the benefit range in which you wish to train, you must first determine your Maximum Heart Rate. This can be accomplished by using the following formula: 220 minus your age. This will give you the Maximum heart rate (MHR) for someone of your age. To determine the effective heart rate range for specific goals you simply calculate a percentage your MHR. Your Heart rate training zone is 50% to 90% of your maximum heart rate. 60% of your MHR is the zone that burns fat while 80% is for strengthening the cardio vascular system. This 60% to 80% is the zone to stay in for maximum benefit.

For someone who is 40 years old their target heart rate zone is calculated:

$$\begin{aligned} 220 - 40 &= 180 \text{ (maximum heart rate)} \\ 180 \times .6 &= 108 \text{ beats per minute (60\% of maximum)} \\ 180 \times .8 &= 144 \text{ beats per minute (80\% of maximum)} \end{aligned}$$

So for a 40 year old the training zone would be 108 to 144 beats per minute.

If you enter your age during programming the console will perform this calculation automatically. Entering your age is used for the Heart Rate control programs. After calculating your Maximum Heart Rate you can decide upon which goal you would like to pursue.

The two most popular reasons for, or goals, of exercise are cardiovascular fitness (training for the heart and lungs) and weight control. The black columns on the chart above represent the Maximum Heart Rate for a person whose age is listed at the bottom of each column. The training heart rate, for either cardiovascular fitness or weight loss, is represented by two different lines that cut diagonally through the chart. A definition of the lines' goal is in the bottom left-hand corner of the chart. If your goal is cardiovascular fitness or if it is weight loss, it can be achieved by training at 80% or 60%, respectively, of your Maximum Heart Rate on a schedule approved by your physician. Consult your physician before participating in any exercise program.

With all Heart Rate Control elliptical machines you may use the heart rate monitor feature without using the Heart Rate Control program. This function can be used during manual mode or during any of the nine different programs. The Heart Rate Control program automatically controls resistance at the pedals.

”WARNING” Heart rate monitoring system may be inaccurate. Over exercise may result in injury or death. If you feel faint stop exercising immediately.

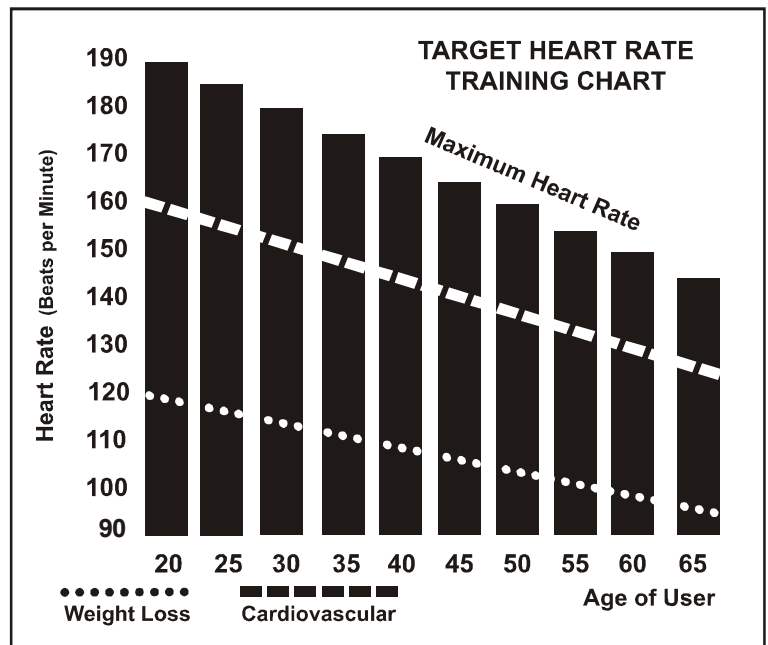

RATE OF PERCEIVED EXERTION

Heart rate is important but listening to your body also has a lot of advantages. There are more variables involved in how hard you should workout than just heart rate. Your stress level, physical health, emotional health, temperature, humidity, the time of day, the last time you ate and what you ate, all contribute to the intensity at which you should workout. If you listen to your body, it will tell you all of these things.

The rate of perceived exertion (RPE), also know as the Borg scale, was developed by Swedish physiologist G.A.V. Borg. This scale rates exercise intensity from 6 to 20 depending upon how you feel or the perception of your effort.

The scale is as follows:

Rating Perception of Effort

- 6 Minimal
- 7 Very, very light
- 8 Very, very light +
- 9 Very light
- 10 Very light +
- 11 Fairly light
- 12 Comfortable
- 13 Somewhat hard
- 14 Somewhat hard +
- 15 Hard
- 16 Hard +
- 17 Very hard
- 18 Very hard +
- 19 Very, very hard
- 20 Maximal

You can get an approximate heart rate level for each rating by simply adding a zero to each rating. For example a rating of 12 will result in an approximate heart rate of 120 beats per minute. Your RPE will vary depending up the factors discussed earlier. That is the major benefit of this type of training. If your body is strong and rested, you will feel strong and your pace will feel easier. When your body is in this condition, you are able to train harder and the RPE will support this. If you are feeling tired and sluggish, it is because your body needs a break. In this condition, your pace will feel harder. Again, this will show up in your RPE and you will train at the proper level for that day.

USING HEART RATE TRANSMITTER (Optional)

1. Attach the transmitter to the elastic strap using the locking parts.
2. Adjust the strap as tightly as possible as long as the strap is not too tight to remain comfortable.
3. Position the transmitter with the logo centered in the middle of your body facing away from your chest (some people must position the transmitter slightly left of center). Attach the final end of the elastic strap by inserting the round end and, using the locking parts, secure the transmitter and strap around your chest.

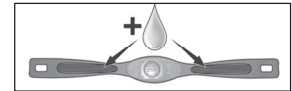
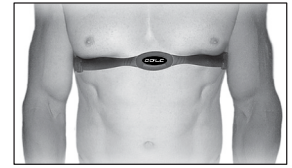

4. Position the transmitter immediately below the pectoral muscles.
5. Sweat is the best conductor to measure very minute heart beat electrical signals. However, plain water can also be used to pre-wet the electrodes (2 ribbed oval areas on the reverse side of the belt and both sides of the transmitter). It's also recommended that you wear the transmitter strap a few minutes before your work out. Some users, because of body chemistry, have a more difficult time in achieving a strong, steady signal at the beginning. After "warming up", this problem lessens. As noted, wearing clothing over the transmitter/strap doesn't affect performance.
6. Your workout must be within range - distance between transmitter/receiver – to achieve a strong steady signal. The length of range may vary somewhat but generally stay close enough to the console to maintain good, strong, reliable readings. Wearing the transmitter immediately against bare skin assures you of proper operation. If you wish, you may wear the transmitter over a shirt. To do so, moisten the areas of the shirt that the electrodes will rest upon.

Note: The transmitter is automatically activated when it detects activity from the user's heart. Additionally, it automatically deactivates when it does not receive any activity. Although the transmitter is water resistant, moisture can have the effect of creating false signals, so you should take precautions to completely dry the transmitter after use to prolong battery life (estimated transmitter battery life is 2500 hours). The replacement battery is Panasonic CR2032.

ERRATIC OPERATION

CAUTION! Do not use this exercise equipment for Heart Rate unless a steady, solid Actual Heart Rate value is being displayed. High, wild, random numbers being displayed indicate a problem.

Areas to look for interference which may cause erratic heart rate:

1. Microwave ovens, TV's, small exercise equipments, etc.
2. Fluorescent lights.
3. Some household security systems.
4. Perimeter fence for a pet.
5. Some people have problems with the transmitter picking up a signal from their skin. If you have problems try wearing the transmitter upside down. Normally the transmitter will be oriented so the logo is right side up.
6. The antenna that picks up your heart rate is very sensitive. If there is an outside noise source, turning the whole machine 90 degrees may de-tune the interference.
7. Another Individual wearing a transmitter within 3' of your machine's console.

If you continue to experience problems contact your dealer.

GENERAL MAINTENANCE

1. Wipe down all areas in the sweat path with a damp cloth after each workout.
2. If a squeak, thump, clicking or rough feeling develops the main cause is most likely one of two reasons:
 - 1) The hardware was not sufficiently tightened during assembly. All bolts that were installed during assembly need to be tightened as much as possible. It may be necessary to use a larger wrench than the one provided if you cannot tighten the bolts sufficiently. I cannot stress this point enough; 90% of calls to the service department for noise issues can be traced to loose hardware.
 - 2) The crank arm nut and/or the pedals need to be retightened.
3. If squeaks or other noises persist, check that the unit is properly leveled. There are 2 leveling pads on the bottom of the rear stabilizer, use a 14mm wrench (or adjustable wrench) to adjust the levelers.

WARNING

The effect that the safety level of the equipment can be maintained only if it is examined regularly for damage and wear.

- 1) Replace defective components immediately and/or keep the equipment out of use until repair.
- 2) The components which are most susceptible to wear: Belt · PU wheel · Bearing · Idler.

MAINTENANCE MODE MENU

The console has built-in maintenance/diagnostic software. The software will allow you to change the console settings from English to Metric and turn off the beeping of the speaker when a key is pressed for example. To enter the Maintenance Mode, pedal the elliptical and press and hold down the Start, Stop and Enter keys. Keep holding the keys down for about 5 seconds and the Message Center will display Maintenance Mode. Press the Enter key to access the menu below:

1. Key Test (Will allow you to test all the keys to make sure they are functioning)
2. Display Test (Tests all the display functions)
3. Sleep Mode (Turn on to have the console power down automatically after 20 minutes of inactivity)
4. Odometer Reset (Resets the odometer)
5. Units (Sets the display to read out in English or Metric display measurements)
6. Speaker (Turns off the speaker so no beeping sound is heard)
7. Brake Test (Tests the brake resistance)
8. Sensor Test (Tests the speed sensor function)
9. Unit Type (Sets machine type; Bike or Elliptical)

EXPLODED VIEW DIAGRAM

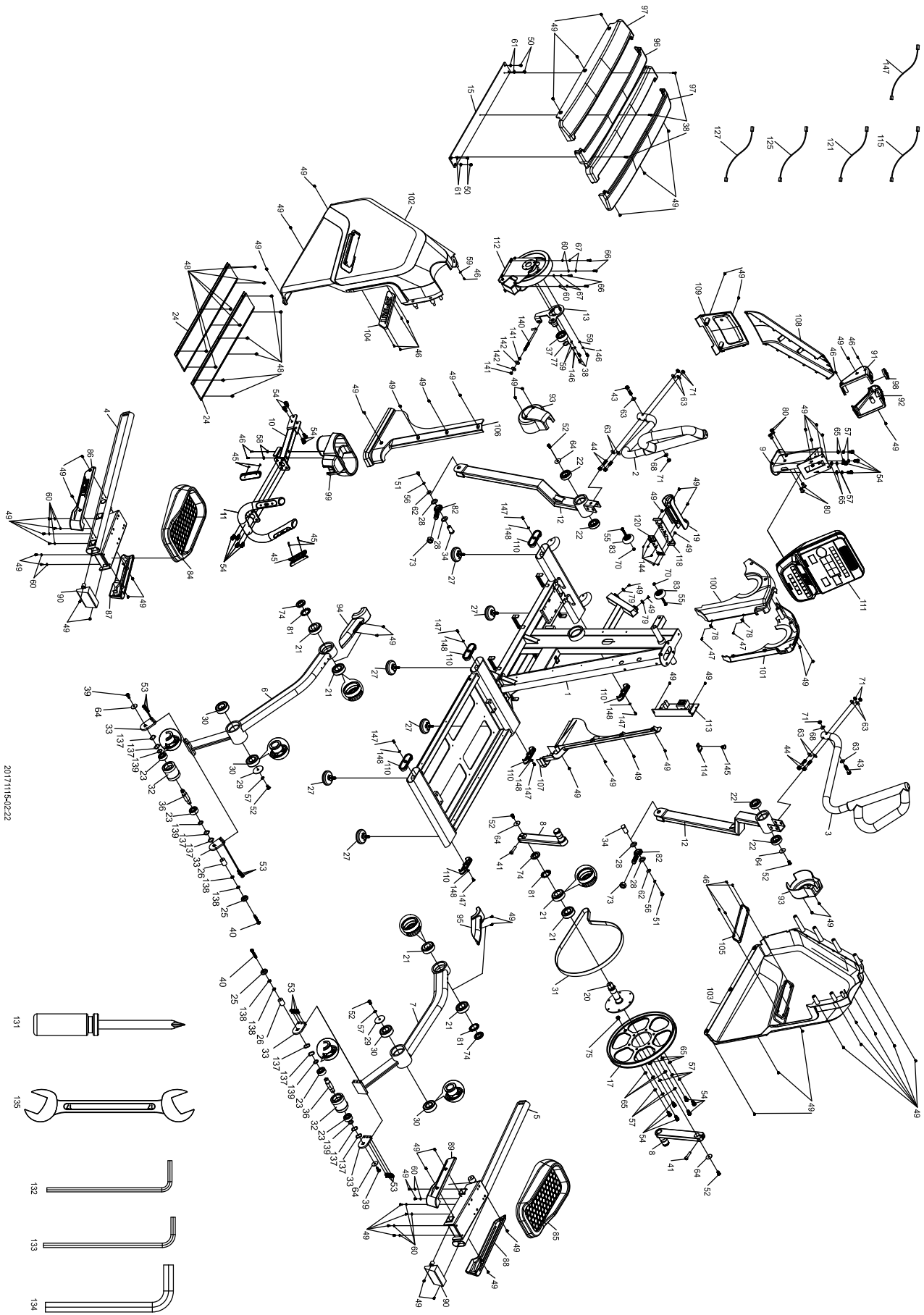

20171115-0222

PARTS LIST

NO.	DESCRIPTION	O'TY
1	Main Frame	1
2	Seat Handle Bar (L)	1
3	Seat Handle Bar (R)	1
4	Connecting Arm (L)	1
5	Connecting Arm (R)	1
6	Pedal Arm (L)	1
7	Pedal Arm (R)	1
8	Crank Arm Assembly	2
9	Console Mast	1
10	Handpulse Assembly	1
11	Handpulse Assembly	1
12	Seat Handle Bar	2
13	Idler Wheel Assembly	1
15	Aluminum Track	1
17	Flywheel Pulley(Ø400×32)	1
20	Arbor	1
21	Ø72 × Ø35 × 24.3T_Bearing	6
22	6206_Bearing	4
23	Ø47 × Ø20 × 18T_Bearing	4
24	Rail	2
25	PU Wheel	2
26	Arbor	2
27	Foot Pad	6
28	Ø20.7 × Ø45 × 2.5T_Flat Washer	2
29	Ø59 × 3T_Wheel Cover	2
30	Ø72 × Ø35 × 23T_Bearing	4
31	Drive Belt	1
32	Transportation Wheel	2
33	Back Plate	4
34	Rod End Sleeve	2
36	Transportation Wheel Axle	2
37	Ø59 × 26T_Bearing	1
38	M5 × 15m/m_Socket Head Cap Bolt	3
39	M8 × 20m/m_Socket Head Cap Bolt	2
40	M8 × 55m/m_Socket Head Cap Bolt	2
41	M10 × 60m/m_Socket Head Cap Bolt	2
43	M10 × 55m/m_Socket Head Cap Bolt	2
44	M10 × 60m/m_Socket Head Cap Bolt	4
45	3 × 20m/m_Tapping Screw	4
46	3.5 × 12m/m_Sheet Metal Screw	13
47	5 × 16m/m_Sheet Metal Screw	2
48	M6 × 10m/m_Phillips Head Screw	12

NO.	DESCRIPTION	O'TY
49	M5 × P0.8 × 12L_Phillips Head Screw	75
50	M8 × 12m/m_Button Head Socket Bolt	4
51	M8 × P1.25 × 15m/m_Socket Head Cap Bolt	2
52	M10 × P1.5 × 15m/m_Button Head Socket Bolt	6
53	M10 × 20m/m_Socket Head Cap Bolt	12
54	M10 × P1.5 × 20m/m_Socket Head Cap Bolt	18
55	5/16" × 1-3/4" Button Head Socket Bolt	2
56	Ø8.5 × 1.5T_Split Washer	2
57	Ø10 × 2T_Split Washer	12
58	Ø4 × 14 × 1.0T_Flat Washer	2
59	Ø5 × Ø15 × 1.0T_Flat Washer	12
60	Ø6.6 × Ø12 × 1.5T_Flat Washer	16
61	Ø8.5 × Ø16 × 1.5T_Flat Washer	4
63	Ø10 × Ø25 × 1.5T_Flat Washer	10
64	Ø3/8" × 35 × 2.0T_Flat Washer	8
65	Ø3/8" × Ø19 × 1.5T_Flat Washer	10
66	1/4" × UNC20 × 3/4" Hex Head Bolt	4
67	Ø1/4" Split Washer	4
68	Ø10 × Ø23 × 1.5T_Curved WasherR38	2
70	5/16" × 7T_Nyloc Nut	2
71	M10 × 8T_Nyloc Nut	8
73	M20 × 15T_Nut	2
74	M35 × P1.5 × 8T_Nut	3
75	Magnet(Ø15×7T)	1
77	Ø28_C Ring	1
78	M5 × P0.8 × 1T_Plate	2
79	M5_Speed Nut Clip	2
80	M10 × 1.5L_Hex Blind Nut	8
81	Bolt	3
82	Rod End Bearing	2
83	Transportation Wheel(PU.Ø65)	2
84	Pedal (L)	1
85	Pedal (R)	1
86	Pedal Arm Cover A(L)	1
87	Pedal Arm Cover B(L)	1
88	Pedal Arm Cover A(R)	1
89	Pedal Arm Cover B(R)	1
90	Rear Shroud	2
91	Chin Cover(L)	1
92	Chin Cover(R)	1
93	Handle Bar Cover	2
94	Cover (L)	1
95	Cover (R)	1
96	Slide Wheel Cover A	1

NO.	DESCRIPTION	O'TY
97	Slide Wheel Cover B	2
98	Protective Rubber	1
99	Drink Bottle Holder	1
100	Console Mast Cover(L)	1
101	Console Mast Cover(R)	1
102	Side Case (L)	1
103	Side Case (R)	1
104	Side Case Plate(L)	1
105	Side Case Plate(R)	1
106	Console Mast Inner Cover(L)	1
107	Console Mast Inner Cover(R)	1
108	Front Shroud	1
109	Power Switch Cover	1
110	Cap	6
111	Console Assembly	1
112	Generator/Resistance	1
113	Generator/Brake Controller	1
114	300m/m_Sensor W/Cable	1
115	1100m/m_Handpulse Wire	2
117	30m/m_Handpulse W/Cable Assembly	2
121	Power Cord	1
125	1400m/m_Computer Cable	1
127	400m/m_Wire Brake Coil Harness(Red)	1
131	Phillips Head Screw Driver	1
132	L Allen Wrench(5×26×120L)	1
133	6_L Allen Wrench	1
134	8mm L Allen Wrench	1
135	17m/m_Wrench	1
137	Ø20_Wave Washer	8
138	Ø8 × 1.5T_Spring Washer	4
139	Back Plate	4
140	M8 × 170m/m_J Bolt	1
141	M8 × 6.3T_Luck Nut	2
142	Ø3/8" × Ø25 × 2.0T_Flat Washer	2
145	M5 × 10L_Phillips Head Screw	1
146	Ø5 × 1.5T_Spring Washer	3
147	M5 × P0.8 × 15L_Phillips Head Screw	6
148	Ø1/4" × 13 × 1.0T_Flat Washer	6
149	Ø20.3 × Ø38 × 2T_Flat Washer	2